

## ART. 204.WDxxx

### MONTAGGIO / MOUNTING / MONTAGE / MONTAJE

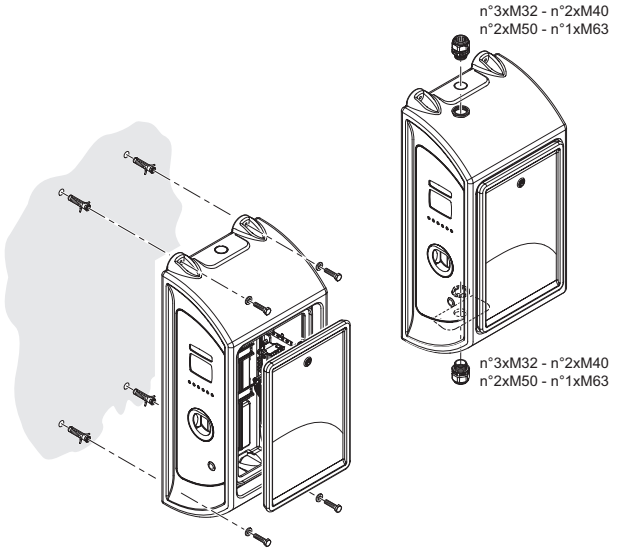
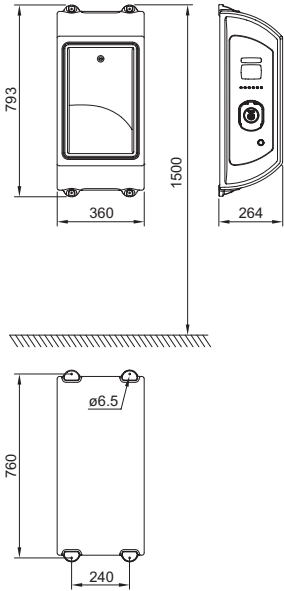

### CABLAGGIO / WIRING / CÂBLAGE / CABLEADO

L-L: 380 ÷ 400 Vac  
 L-N: 220 ÷ 230 Vac  
 N-PE : < 5 Vac  
 f: 50/60 Hz  
 Rt: < 150 Ω  
 THD: < 8%

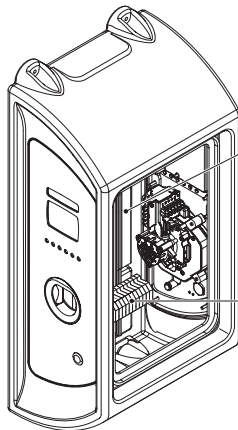

#### SERIAL LINE



0,5 mm<sup>2</sup>  
 ES. BELDEN 9841

#### TCP/IP LINE



RJ45  
 CAT5

#### POWER SUPPLY

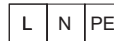

2,5+35 mm<sup>2</sup>

OR

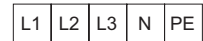

2,5+35 mm<sup>2</sup>

(dimensioni in mm) / (dimensions in mm)  
 (dimensiones en mm) / (dimensiones en mm)

## FUNZIONAMENTO / WORKING / FONCTIONNEMENT / OPERACIÓN

### FREE

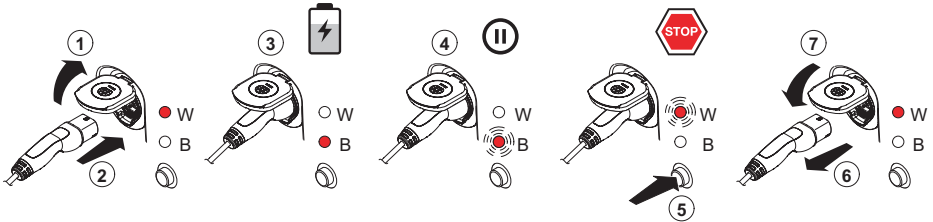

### PERSONAL

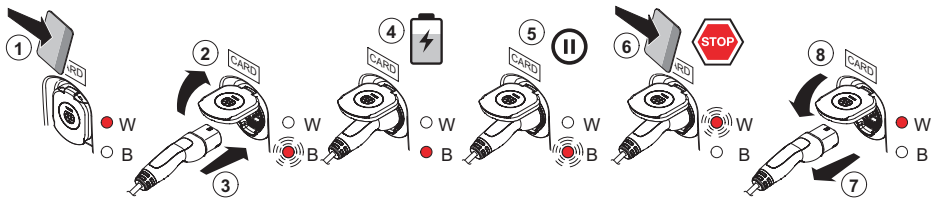

W: WHITE  
B: BLUE

**InfoTECH**

|  |  |
|--|--|
| ITALY<br>Numero Verde<br><b>800-018009</b> | WORLDWIDE<br><b>ScameOnLine</b><br>www.scame.com<br>infotech@scame.com |
|--|--|



### NOTE / NOTES / NOTES / NOTAS

Questo apparecchio deve essere installato e sottoposto a manutenzione da personale qualificato.  
 This device shall be installed and maintained by qualified personnel.  
 Cet appareil doit être installé et entretenu par du personnel qualifié.  
 Este aparato debe ser instalado y mantenido por persona! calificado.

Il costruttore non può essere ritenuto responsabile del mancato rispetto delle presenti istruzioni.  
 The manufacturer can not be held responsible for any failure to comply with these instructions.  
 Le fabricant ne peut être tenu responsable du non-respect de ces instructions.  
 El fabricante no se hace responsable por el incumplimiento de estas instrucciones.

Per scaricare il manuale d'uso delle stazioni di ricarica visitate il nostro sito web:  
 To download the user manual of charging stations visit our website:  
 Pour télécharger le manuel d'utilisation des bornes de recharge, visitez notre site web:  
 Para descargar el manual del usuario de las estaciones de carga, visite nuestro sitio web:  
**<http://ecomobility.scame.com/>**